

1617008

USER'S MANUAL

SUPER SLIM DIVX/MPEG4 DVD PLAYER



NEXXTTECHTM MC



PLEASE CAREFULLY READ THIS MANUAL BEFORE OPERATING THIS UNIT

SAFETY INFORMATION



The light flash with an arrowhead symbol, within an equilateral triangle, is intended to alert the user to the presence of uninsulated "dangerous voltage" within the product's enclosure that may be of sufficient magnitude to constitute a risk of electric shock to persons.



The exclamation point within the equilateral triangle is intended to alert the user to the presence of important operating and maintenance (servicing) instructions in the literature accompanying the appliance.

This digital video disc player employs a laser system.

Use of controls, adjustment or the performance of procedures other than specified may result here in hazardous radiation exposure.

Visible laser radiation when open and interlocks defeated.

DO NOT STARE INTO BEAM.

FCC NOTICE:

This equipment has been tested and found to comply with the limits for a Class B digital device, pursuant to part 15 of the FCC rule. These limits are designed to provide reasonable protection against harmful interference in a residential installation. This equipment generates uses and can radiate radio frequency energy and, if not installed and used in accordance with the instructions, it may cause harmful interference to radio communications. However, this is no guarantee that interference will not occur in a particular installation.

If this equipment does not cause harmful interference to radio or television reception, which can be determined by turning the equipment off or on, the user is encouraged to try to correct the interference by one or more of the follow measures.

- Reorient or relocate the receiving antenna.
- Increase the separation between the equipment and receiver.
- Connect the equipment into an outlet on a circuit different from that to which the receiver is connected.
- Consult the dealer or an experienced radio/TV technician for help.

This product incorporates copyright protection technology that is protected by method claims of certain U.S. patents and other intellectual property rights owned by macrovision corporation and other rights owners. Use of this copyright protection technology must be authorized by Macrovision Corporation and is intended for home and other limited viewing uses only unless otherwise authorized by Macrovision Corporation. Reverse engineering or disassembly is prohibited.

IMPORTANT SAFETY INSTRUCTIONS

- 1) Read these instructions.
- 2) Keep these instructions.
- 3) Heed all warnings.
- 4) Follow all instructions.
- 5) Do not use this apparatus near water.
- 6) Clean only with dry cloth.
- 7) Do not block any ventilation openings. Install in accordance with the manufacturer's instructions.
- 8) Do not install near any heat sources such as radiators, heat registers, stoves, or other apparatus (including amplifiers) that produce heat.
- 9) Do not defeat the safety purpose of the polarized or grounding-type plug. A polarized plug has two blades with one wider than the other. A grounding type plug has two blades and a third grounding prong. The wide blade or the third prong are provided for your safety. If the provided plug does not fit into your outlet, consult an electrician for replacement of the obsolete outlet.
- 10) Protect the power cord from being walked on or pinched particularly at plugs, convenience receptacles and the point where they exit from the apparatus.
- 11) Only use attachments/accessories specified by the manufacturer.



- 12) Use only with the cart, stand, tripod, bracket or table specified by the manufacturer or sold with the apparatus. When a cart is used, use with caution when moving the cart/apparatus combination to avoid injury from tip-over.
- 13) Unplug this apparatus during lightning storms or when unused for long period of time.
- 14) Refer all servicing to a qualified service personnel. Servicing is required when the apparatus has been damaged in any way, such as power supply cord or plug is damaged, liquid has been spilled or objects have fallen into the apparatus has been exposed to rain or moisture, does not operate normally, or has been dropped.
- 15) **"WARNING"** To reduce the risk of fire or electric shock, do not expose this apparatus to rain or moisture.
- 16) **"CAUTION"** These servicing instructions are for use by qualified service personnel only. To reduce the risk of electric shock do not perform any servicing other than that contained in the operating instruction unless you are qualified to do so.

TABLE OF CONTENTS

Safety Information

Table of Contents

DVD Player User's Manual

1. Types of discs your DVD player will play	3
2. Front and Rear panel illustrations	4
3. Remote control	5

System connection

1. System connection	7
2. System connection to a TV set	8
3. System connection to an Amplifier	9

Chapter 1: Basic Operation

1. Turn on your DVD player	10
2. Place a disc into the tray	10
3. Playing discs	10
a) Menu Play	10
b) Title Play	11
c) Sequence Play	11
d) Program Play	11

Chapter 2: Additional Operation

1. Selecting Tracks	12
2. Skipping Tracks	12
3. Multispeed Fast Motion Playback	12
4. Multispeed Slow Motion Playback	13
5. Freeze Frame and Frame Advance	13
6. Using the Repeat Feature	13
7. Using the Display Feature	13
8. Using the Search Feature	14
9. Using the Browse / Scan / Index feature	14
10. Changing the Soundtrack	15
11. Changing the Audio Language	15
12. Subtitles	16
13. Changing the Camera Angle	16
14. Changing the TV System	16
15. Mute the Audio Output	16
16. Zoom in the Video Image	17
17. Repeat a Specific Segment on the Disc that you define	17
18. 3D Surround Mode	17
19. Volume control	19

Chapter 3: MPEG-4 and Divx	20
----------------------------------	----

TABLE OF CONTENTS

Chapter 4: The Setup Menu System

1. General Steps of Setup Menu	21
2. Setup Items Introduction	21
a) System Setup	21
b) Language Setup	23
c) Audio Setup	24
d) Video Setup	24
e) Speaker Setup	25
f) Digital Setup	26
Troubleshooting	28
Specifications	30

DVD USER'S MANUAL

1. Types of Discs your DVD player will play

Types of Discs	Diameter	Playback Time	Data Format	Remark
MPEG-4	4.7" (12cm)	74 min.	MPEG-4	
	3" (8cm)	20 min.		
Divx	4.7" (12cm)	74 min.	Divx 3.11-5.11	
	3" (8cm)	20 min.		
DVD	4.7" (12cm)	1 layer: 12 min.	DVD Format Disc: Compressed Digital Audio Compressed Digital Video (Moving picture)	
		2 layers: 240 min.		
	3" (8cm)	1 layer: 80 min.		
		2 layers: 180 min.		
SVCD	4.7" (12cm)	45 min.	MPEG2 Compressed Digital Audio Compressed Digital Video (Moving picture)	Include: SVCD CVD
VCD	4.7" (12cm)	74 min.	MPEG1 Compressed Digital Audio Compressed Digital Video (Moving picture)	Include: VCD2.0 VCD1.1 VCD1.0 DVCD
	3" (8cm)	20 min.		
CD	4.7" (12cm) 3" (8cm)	min. min.	CD-DA: Digital Audio	
HD-CD	4.7" (12cm)	min.	HD-CD: Digital Audio	
DTS-CD	4.7" (12cm)	min.	DTS-CD: Digital Audio	
MP3/JPEG	4.7" (12cm)	600 min.	Compressed Digital Audio	

* **Note:** DVD-R, CD-R, CD-RW discs can be played in this DVD player.

DVD USER'S MANUAL

2. Front and Rear panel illustraion

FRONT PANEL

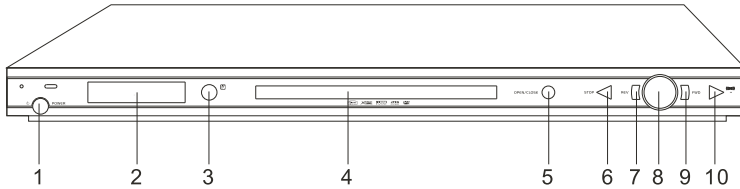

1. POWER button
2. VFD
3. Remote control receiver.
4. Disc tray.
5. OPEN/CLOSE button.

6. STOP button.
7. Fast reverse button.
8. PLAY/PAUSE button.
9. Fast forward button.
10. L/R

REAR PANEL

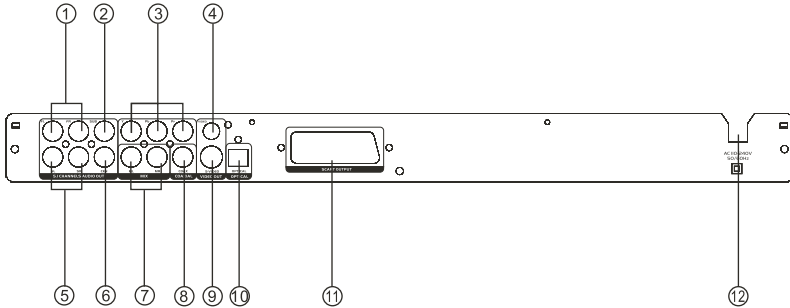

1. 5.1 Channels Front (Left/Right) Audio out
2. 5.1 Channels Subwoofer Audio out
3. YPbPr Component Video out
4. Composite Video out
5. 5.1 Channels Surround (Left/Right) Audio out
6. 5.1 Channels Center Audio out

7. DownMix Left/Right Audio out
8. Coaxial output
9. S-Video output
10. Optical output
11. Scart output (Optional)
12. AC 110-240V 50/60Hz

3. Remote control

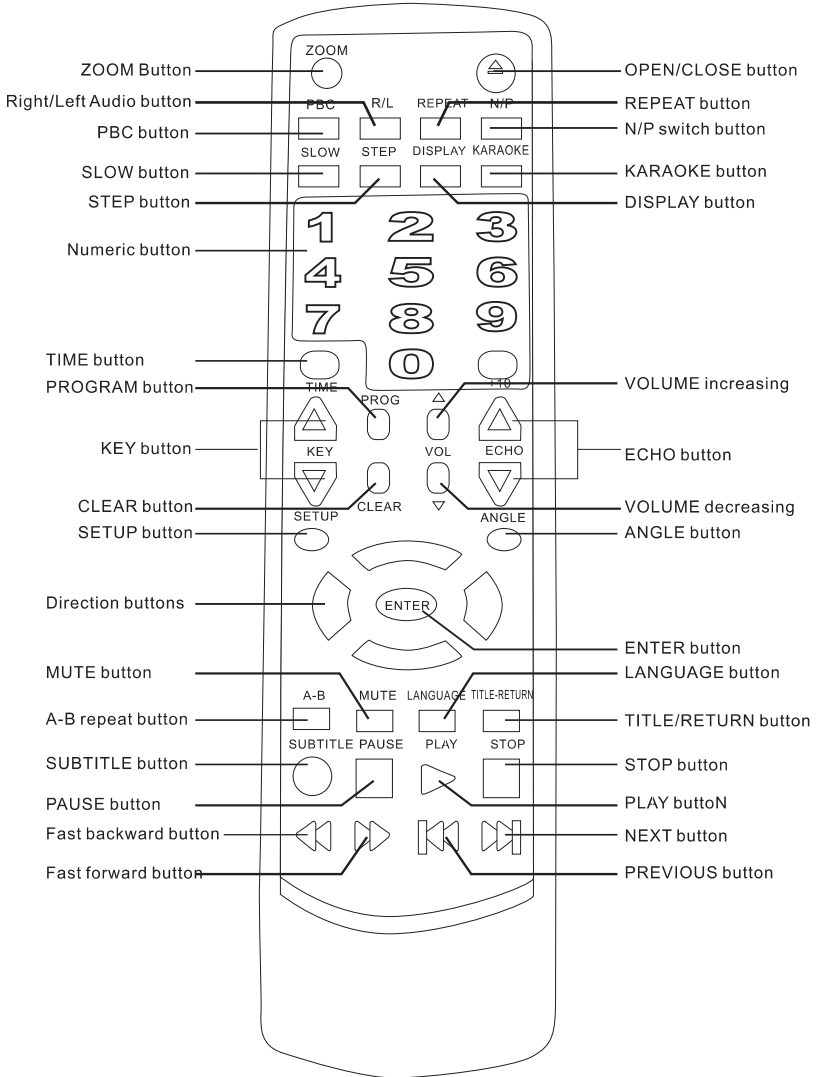

NOTE:

- KARAOKE, KEY and ECHO buttons are available only for DVD player with Karaoke function.

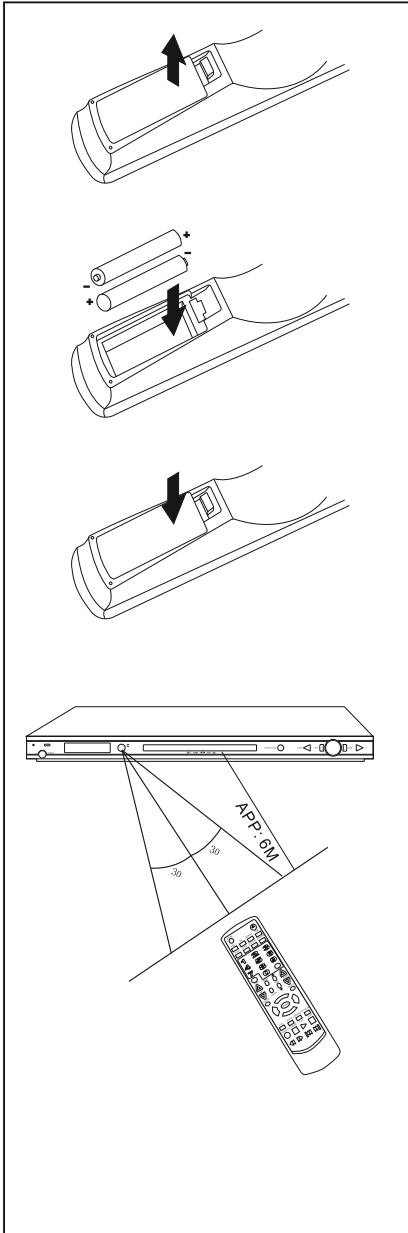

Battery Installation:

1. Push downward and outward the leaf spring to remove the battery compartment cover.
2. Insert two size AAA batteries according to the "+" and "-" markings.

Note:

- A. Do NOT mix different types together, or old batteries with new batteries.
- B. If the remote control is not used for an extended period of time, remove the batteries to prevent possible corrosion.
- C. To prevent corrosion resulting in damage, remove exhausted batteries immediately. If the remote control doesn't appear to operate normally, replace both of the batteries.
- D. Typical life for the batteries provided with this product is about 6 months. The life expectancy may vary according to the use status.

Use of the remote control

Point the remote control toward the remote sensor on your DVD home theater center. Upon receipt of the signal from the remote control, the equipment will operate accordingly. The description in this manual is based on the buttons on the equipment. You may use the counterparts on the remote control to do the same.

Note:

- A. Do not place this equipment in a place exposed to direct sunlight or strong light source like inverting fluorescent light, or else it may interfere with correct operation of the remote controller.
- B. When other similar remote control is used in the same room, or when this product is used near other equipment using infrared ray, interference with the operation of this remote control may occur.
- C. Do not place any object on the remote control or else it may cause unintentional depression of the buttons and waste the batteries unnecessarily.
- D. The front of the chassis should not be glazed with coloured glass, or else it may cause interference with normal operation of the remote control.
- E. Any barrier between the remote control and remote sensor could interfere with the operation of the remote control.
- F. The operating range between the remote control and the equipment shall be no more than 16 feet (5 meters). When the operating range becomes shorter, replace the batteries with new ones.

SYSTEM CONNECTION

1. System connection

⚠ DO NOT connect the AC power socket to the wall outlet before the system connection is completed.

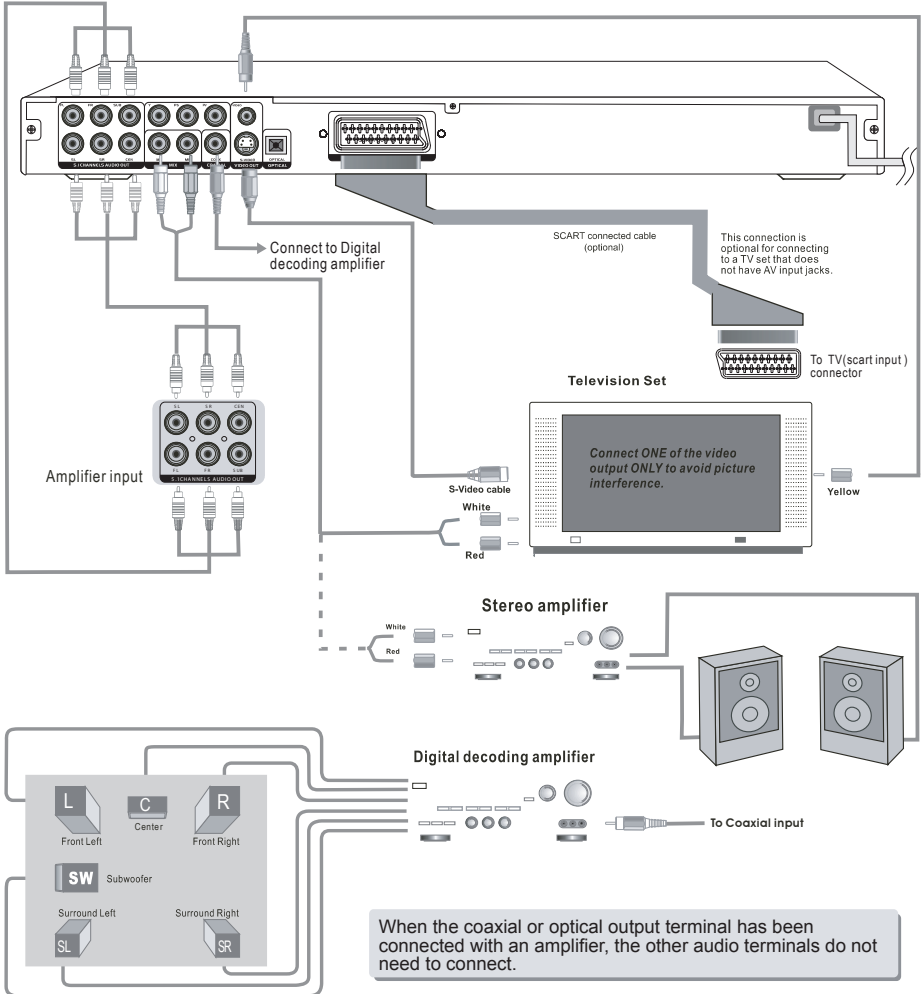

SYSTEM CONNECTION

2. System connection to a TV set

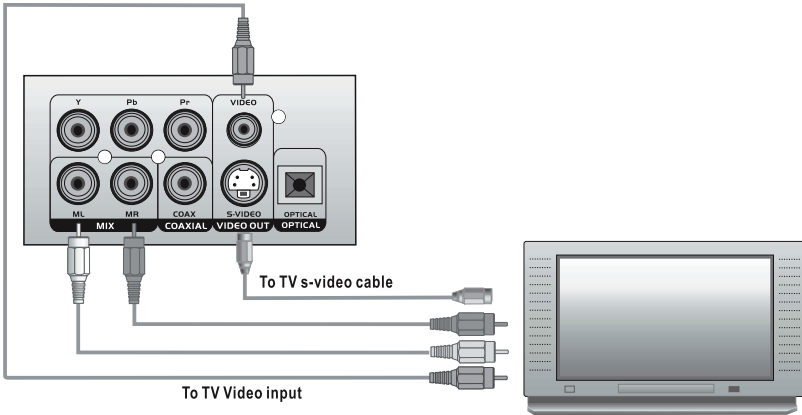

Diagram 1

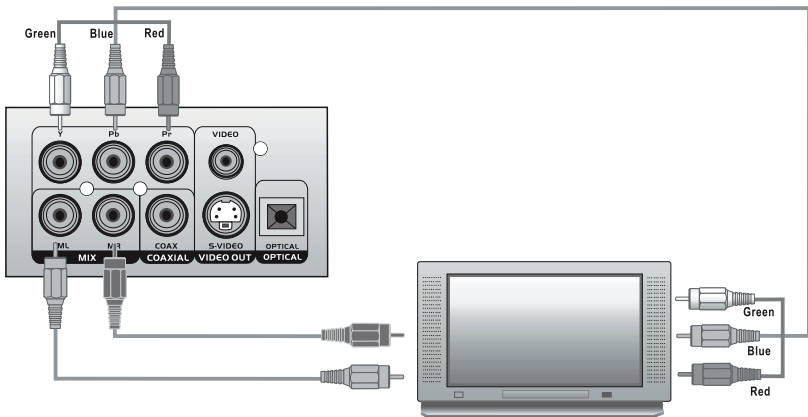

Diagram 2

1. The player is equipped with composite A/V outputs at the rear of the player. Your TV will require at least one set of A/V inputs. The patch cord supplied with the player will connect the A/V output jack of your player to your TV's inputs.
2. To view the DVD signal, please press the "AV/TV" button on the TV or remote control of your TV to switch TV's mode from broadcast reception mode to one of the A/V signals. Your TV should have more than one A/V input.

3. The player is equipped for stereo playback. To fully realize the 2 channel sound, a Stereo TV or A/V receiver is necessary. However, a Mono TV may be used providing the TV has one set of A/V inputs. The A/V inputs on a Mono TV will only include one Audio input for Mono sound. You may connect either the Left or Right audio channel from the DVD composite audio out to the Mono TV audio input.

SYSTEM CONNECTION

3. System connection to an Amplifier

a. Audio connecting to a stereo Amplifier

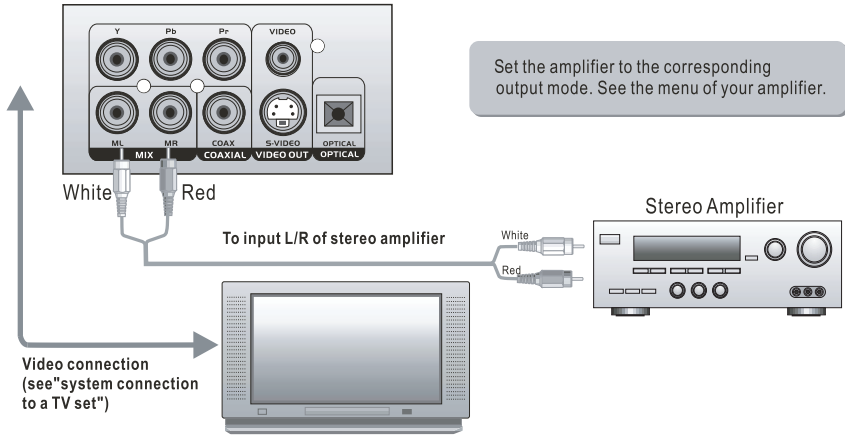

b. Digital audio connection to a digital Amplifier

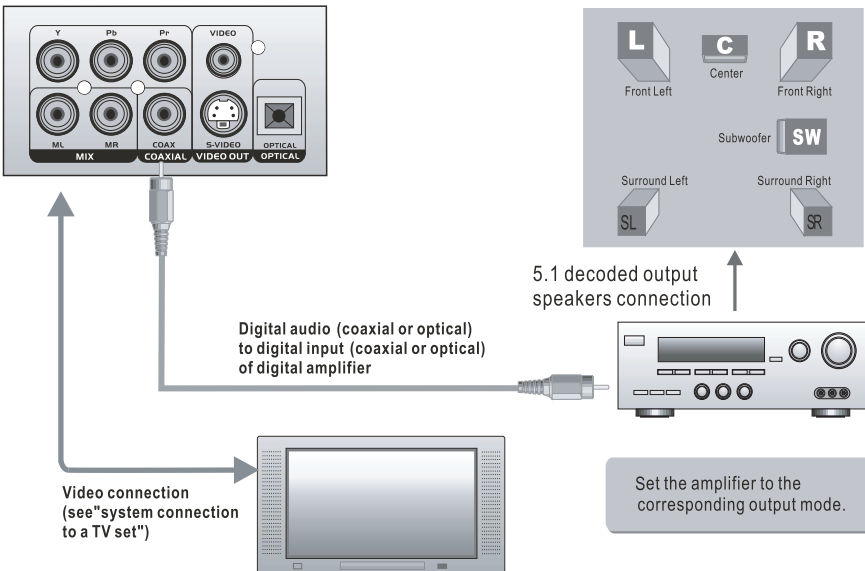

BASIC OPERATION

Chapter 1: Basic Operation

1. Turn on the TV and your DVD player

Press the Power button on the player or the remote control and "Read" appears on the TV screen. If there is no disc in the DVD player, "No disc" will be displayed on both the screen and the VFD.

2. Place a Disc into the tray

Press the Open/Close button located on the remote control or the front of the DVD player and "Open" appears on the screen. Then place a disc gently onto the tray with the disc's label facing up (double sided discs have content on both sides, so you can place either side up). Press the Open/Close button again to close the disc tray and "Close" appears and the player starts to read. Then the disc will start playing automatically. (**Note:** With certain types of discs, you may need to press the Play or Enter button to start playing).

3. Play discs

The contents of each disc menu may vary according to how the disc was recorded and what features are included. The disc menu will display when the Menu button is pressed. Also "Play" and "Pause" can be pressed using the "Pause" button on the remote. Similar to the "Menu" play, other play modes such as "title" play and "sequence" play can also be accessed.

a) Menu Play (compatible with DVD, SVCD, VCD2.0 discs)

I. Press Menu Button

- TV screen displays the DVD main Menu when a DVD disc is loaded.
- When a SVCD or VCD 2.0 disc is loaded, SVCD or VCD 2.0 menu will be displayed on the screen (when PBC is off). (At this moment, press PBC button once to display current PBC state).
- PBC is initialized on when a SVCD or VCD 2.0 disc is loaded.

II. When a DVD disc is loaded, you can press the Arrow buttons to highlight the menu item you want to choose; As SVCD or VCD 2.0, you can press the Numeric buttons to select a track to play.

III. Press the Enter or Play button and you can begin play with the highlighted.

IV. Return when playing: When a DVD disc is playing, press the Menu (PBC) button and you can return to the main Menu; As SVCD, VCD 2.0 and PBC is on, press Menu (PBC) button and you can return to the menu.

V. Stop

- 1) When you press the Stop button for the first time, the player turns into a quasi stop state. At the same time the OSD appears "Quasi Stop". To begin the title over, press Stop twice.
- 2) In quasi stop state, the player remembers where you stopped. When you start playing the disc again, the DVD player will pick up where you left off.
- 3) In stop state, when you press Play, the player enters sequence playback mode.
 - For the disc protection, before you press Open/Close button to eject the disc tray when playing, please press Stop button first. After taking out the disc, press OPEN/CLOSE again to close the tray.
 - If you're not going to use the DVD player for a long time, be sure to unplug the player.

BASIC OPERATION

b) Title Play (compatible with DVD discs only)

- I. During DVD playback, press the Title button to display the DVD title content.
- II. Press the Arrow buttons to highlight the title you want to select and press Enter. You can also press the Numeric buttons to select.
- III. The DVD player begins with the chapter 1 of the chosen title.

c) Sequence Play (compatible with DVD, SVCD, VCD, CD-G, DTS-CD, HD-CD, MP3/JPEG discs)

- I. When a SVCD or VCD disc is loaded and PBC is on, once the PBC button is pressed, PBC switches off. Then the player can play in sequence playback mode; when PBC button is pressed twice, PBC switches on.
- II. Except for SVCD or VCD discs, in the stop state, when you press the Play button, the player then enters sequence playback mode. This feature is effective to all the compatible discs.

d) Program Play (compatible with DVD, SVCD, VCD, CD, CD-G, DTS-CD, HD-CD, MP3/JPEG discs)

The Program Playback option allows you to enter the order in which you want chapters or tracks to play, maximum to 16.

- Program Menu:

DVD, MP3/JPEG discs:

PROG		T C		T C		T C		T C	
--:--	--:--	--:--	--:--	--:--	--:--	--:--	--:--	--:--	--:--
--:--	--:--	--:--	--:--	--:--	--:--	--:--	--:--	--:--	--:--
--:--	--:--	--:--	--:--	--:--	--:--	--:--	--:--	--:--	--:--
--:--	--:--	--:--	--:--	--:--	--:--	--:--	--:--	--:--	--:--
		<PLAY>		<CLEAR>					

SVCD, VCD, CD, CD-G, HD-CD, DTS-CD discs:

PROG			
1[- -]	5[- -]	9[- -]	13[- -]
2[- -]	6[- -]	10[- -]	14[- -]
3[- -]	7[- -]	11[- -]	15[- -]
4[- -]	8[- -]	12[- -]	16[- -]
		<PLAY>	
		<CLEAR>	

- * If PBC is on, this operation will turn PBC off while the chapters/tracks plays in programmed order.
- * According to the highlight, use the Numeric buttons to enter the chapters/tracks in the order you want them to play. Then press Play or use the Arrow buttons to highlight the "PLAY" item and press Enter. The chapters/tracks will play in the programmed order.
- * You can program a maximum of 16 titles/chapters/tracks.
- * According to the Direction indicator on the menu, you can press the Arrow buttons to highlight where you want to enter.
- * During Program Playback, if the Program button is pressed, the programmed order and the contents will be displayed on the screen and the Program Playback will be stopped; Also you can press Stop and Play to resume normal playback.

Notes:

- * To clear the programmed order, use the Arrow buttons to highlight the "CLEAR" item, then press Enter.
- * To modify the programmed order, use the Arrow buttons to highlight the modifying item and enter the new chapter/track you want to program directly.
- * Meanwhile, the program indicator in the VFD illuminate and the playing chapter/track also illuminate.

ADDITIONAL OPERATION

Chapter 2: Additional Operation

1. Selecting Tracks (compatible with DVD, SVCD, VCD, CD, CD-G, DTS-CD, HD-CD, MP3/JPEG discs)

- a) When playing a DVD disc, press the Numeric buttons on the menu or title page to select tracks; During DVD playback, you can input the desired title number directly.
- b) As a SVCD or VCD disc, during sequence playback, press the Numeric buttons to select tracks. (During Program Playback and PBC is on, you can only press Prev/Next button to select).
- c) As for CD, CD-G, HD-CD, DTS-CD discs, press the Numeric buttons to select different tracks on current track list.
- d) When playing MP3/JPEG discs, press the Numeric buttons to select different tracks on current track list.

Notes: To select tracks from 1 to 10, press corresponding Numeric buttons (1-9, 10).

To select tracks above 10, press 10+ button. For example, to select track 15, press 10+ and 5 button. If the selected track is not available, the input would be invalid.

2. Skipping Tracks (compatible with DVD, SVCD, VCD, CD, CD-G, DTS-CD, HD-CD, MP3/JPEG discs)

- a) To skip forward to the beginning of the next title/chapter/track on a disc, press Next on the remote or on the front of the player.
- b) To skip backward to the beginning of the preceding title/chapter/track on a disc:
 - Press the Prev button on the remote or on the front of the player.
 - When playing the last chapter/track on a SVCD or VCD disc with PBC off, pressing the Next button will stop the playback.
 - When playing the first chapter/track, pressing the Prev button will stop the playback; When stopped, pressing the Next/Prev button will be invalid.
 - If a DVD disc is loaded, it varies according to how the disc was configured.

3. Multispeed Fast Motion Playback (compatible with DVD, SVCD, Divx, MPEG-4, VCD, CD, DTS-CD, MP3/JPEG discs)

You can search in forward or reverse mode during playback.

- a) Press the F.F button on the remote during playback to search through a disc. Press the button again on the remote to search for the next speed. Fast Forward Playback has four speeds: X 2, X 4, X 8, X 20. With each consecutive press of the button, the search speed increases. If you press the button five times, Fast Forward Playback cycles back to normal playback.

During DVD playback, when Fast Forward Playback returns to the beginning of the next title/chapter, it resumes normal playback; During SVCD or VCD playback with PBC on, when Fast Forward Playback returns to the beginning of the next track, it resumes normal playback.

 - Press the Play button to resume to normal playback.
 - During CD, HD-CD, MP3 playback with the speed F.F X 2, the player has audio output.
- b) Press the F.R button on the remote during playback to search through a disc. Press the button again on the remote to search for the next speed. Fast Reverse Playback has four speeds: X 2, X 4, X 8, X 20. With each consecutive press of the button, the search speed increases. If you press the button five times, Fast Reverse Playback cycles back to normal playback.

ADDITIONAL OPERATION

During DVD playback, when Fast Reverse Playback returns to the beginning of the playing title/ chapter, it resumes normal playback; During SVCD or VCD playback with PBC on when Fast Reverse Playback returns to the beginning of the playing track, it resumes normal playback.

- Press the Play button to resume normal playback.
- During CD, HD-CD, MP3 playback with the speed F.R X 2, the player has audio output.

4. Multispeed Slow Motion Playback (compatible with MPEG-4, Divx, DVD, SVCD, VCD, CD, CD-G, DTS-CD, HD-CD, MP3/JPEG discs)

Press the Slow button when pictures are moving, you can enter the Slow Motion Playback mode. Press the Slow button on the remote during playback. Press the button again on the remote to play at the next speed. Slow Motion Playback has six speeds: 1/2, 1/3, 1/4, 1/5, 1/6, 1/7. With each consecutive press of the button, the play speed decreases. If you press the button seven times, Slow Motion Playback cycles back to normal playback.

Press the Play button to resume normal playback.

5. Freeze Frame and Frame Advance (compatible with MPEG-4, Divx, DVD, SVCD, VCD, CD, CD-G, DTS-CD, HD-CD, MP3/JPEG discs)

- a) During CD, CD-G, HD-CD, DTS-CD or MP3/JPEG playback, press Pause once to freeze playback; Press the Pause button again or Play button to resume normal playback.
- b) During DVD, SVCD or VCD playback, press Pause once to freeze playback; Press the Pause button again to advance the picture one frame at a time; Press Play to resume normal playback.

6. Using the Repeat Feature (compatible with DVD, SVCD, VCD, CD, CD-G, DTS-CD, HD-CD, MP3/JPEG discs)

While a disc is playing, press the Repeat button once and the repeat banner will appear to show the current repeat mode.

- a) In SVCD, VCD, CD, CD-G, HD-CD, DTS-CD or MP3/JPEG sequence playback mode, press the Repeat button again to turn on repeat mode.
Press the button again on the remote to turn to the next repeat mode. There are three repeat options: Off, Track Repeat and Disc Repeat. With each consecutive press of the button, the repeat mode switches. If you press the button four times, repeat mode cycles back to Off.
- b) In DVD playback, press the Repeat button again to turn on repeat mode. There are three repeat options: Off, Chapter Repeat and Title Repeat. With each consecutive press of the button, the repeat mode switches. If you press the button four times, repeat mode cycles back to Off.
- c) In MP3/JPEG playback, press the Repeat button again to turn on repeat mode. There are four repeat options: Off, Track Repeat, Directory Repeat and Disc Repeat. With each consecutive press of the button, the repeat mode switches. If you press the button five times, repeat mode cycles back to Off.

7. Using the Display Feature (compatible with DVD, SVCD, VCD, CD, CD-G, DTS-CD, MP3/JPEG discs)

- a) Loading and playing DVDs (two pages)
 - Press the Display button once to show the first page:
“Disc Type, Title */* (the playing title / total titles), Chapter */* (the playing chapter / total chapters), Elapsed Time of the Disc”.

ADDITIONAL OPERATION

- Press the button again to show the second page:
“Language */* (the serial number of playing language / the amount of optional languages) or Off, Language Type, Audio Type, Subtitle */* (the serial number of playing subtitle / the amount of optional subtitles) or Off, Angle */* (the serial number of playing angle / the amount of optional angles) or Off”.
- Press the button for the third time, the display menu fades out.
b) Loading and playing SVCD discs (two pages)
- Press the Display button once to show the first page:
“Disc Type, Track */* (the playing track / total tracks), Mute, PBC, Repeat Mode, Elapsed Time of the Playing Track”.
- Press the button again to show the second page:
“Language */* (the serial number of playing language / the amount of optional languages) or Off, Language Type, Audio Type, subtitle */* (the serial number of playing subtitle / the amount of optional subtitles) or Off”.
- Press the button for the third time, the display menu fades out.
c) Loading and playing VCDs
- Press the Display button once to show the first page:
“Disc Type, Track */* (the playing track / total tracks), Mute, Repeat Mode, Elapsed Time of the Playing Track”.
- Press the button again, the display menu fades out.
d) Loading and playing CD, CD-G, DTS-CD, HD-CD, MP3 / JPEG discs
- Press the Display button once to show the first page:
“Disc Type, Track */* (the playing track / total tracks), Mute, Repeat Mode, Elapsed Time of the Playing Track”.
- Press the button again, the display menu fades out.

8. Using the Search Feature (compatible with DVD, MPEG-4, Divx, SVCD, VCD, CD, DTS-CD, HD-CD discs)

You can use the Search feature to select a title / chapter / track number or go to a specific point in a title. Firstly, press the Search (Goto) button on the remote control to bring up the search menu and enter the edit state; Secondly, press the Arrow buttons to highlight the title / chapter / track number or the time option; Thirdly, use the Numeric buttons to enter the title / chapter / track you want to play or the elapsed time you want to go to in that title; At last, press the Enter button to start playback. For example, entering 01:23:56 will start playback one hour, twenty-three minutes and fifty-six seconds into the title. If the input number is illegal, the error information “INVALID KEY” will be displayed on the screen.

• Notes:

- I. This feature does not work in Program Play mode.
- II. If PBC is on, it will turn off automatically when Search Playback starts.
- III. When playing MP3 / JPEG discs, Search Feature does not work.

9. Using the Browse / Scan / Index feature (compatible with SVCD, VCD discs; the scan feature is also compatible with CD, CD-G, DTS-CD, HD-CD discs)

a) Press the Preview button during Stop state.

- I. When a SVCD or VCD disc is loaded, the screen displays small pictures or “thumbnails” of the available tracks. According to the tracks’ sequence on the disc, up to nine thumbnails are displayed per screen and each thumbnail plays 3 seconds.
 - If PBC is on, it will turn off automatically when Browse Playback starts.
 - To view the next nine thumbnails, press the Next button to go forward and the Prev button to go to the previous page.

ADDITIONAL OPERATION

- To exit the menu and resume normal playback from the current track, press the Play button.
 - Each thumbnail has a number in the corner. You can select and play a track by pressing that number on the remote.
- II. When a CD, CD-G, DTS-CD, or HD-CD disc is loaded, according to the tracks' sequence on the disc, each track plays 15 secs.
- You can select a track to start Scan Playback by pressing the Numeric buttons on the remote.
 - To exit the Scan Playback and resume normal playback from the scanning track, press the Play button.
 - During normal playback, press the Preview button to start Scan Playback from current track (If the track has played for more than 15 sec, it will start from the next track).
- b) Press the Preview button again, that is to press the button during Browse Playback, the screen displays big pictures instead of thumbnails. According to the tracks' sequence on the disc, each picture plays 15 sec.
- You can select a track to start Index Playback by pressing the Numeric buttons on the remote.
 - To exit the menu and resume normal playback from the current track, press the Play button.
- c) During normal playback, press the Preview button to show thumbnails of the currently selected track.
- If PBC is on, it will turn off automatically when Browse Playback starts.
 - To view the next nine thumbnails, press the Next button to go forward and the Prev button to go to the previous page.
 - To exit the menu and resume normal playback from the current picture, press the Play button.
 - Each thumbnail has a number in the corner. You can select and play a picture by pressing that number on the remote.

10. Changing the Soundtrack (compatible with SVCD, VCD, CD, CD-G, HD-CD, MP3/JPEG discs)

Press the L/R button to display current soundtrack.

a) Pressing the button can switch soundtracks.

b) Press the button again on the remote to turn to the next soundtrack.

I. When playing a SVCD or VCD disc, there are five soundtracks: Stereo (L/R), L/L, R/R, L/L Auto A/D Detect and R/R Auto A/D Detect. With each consecutive press of the button, the soundtrack switches. If you press the button six times, the soundtrack cycles back to Stereo.

II. When playing a CD, CD-G, DTS-CD, HD-CD, or MP3 disc, there are three: Stereo (L/R), L/L and R/R.

Notes:

Switch to L/L Auto A/D Detect or R/R Auto A/D Detect to have various stanza's (you can have a stanza with the singing on the disc), according to the contents on the disc).

When playing a dual-language VCD movie disc, press the L/R button to select the desired language.

11. Changing the Audio Language (compatible with DVD, SVCD discs)

During disc playback, press Language on the remote once and the audio language info banner appears.

ADDITIONAL OPERATION

When a DVD or SVCD is recorded with multiple soundtracks, you can use the Language feature to temporarily change the audio language (the language of the soundtrack).

There are 8 supported languages: Chinese, English, Japanese, French, Spanish, Portuguese, Germany and Latin. With each consecutive press of the Language button, the audio language switches and the corresponding serial number appears on the screen. For example, "Language Icon: [1 English DTS 6CH] or [Off]" (the availability of the languages are disc-dependent).

12. Subtitles (compatible with MPEG-4, Divx, DVD, SVCD discs)

Press the Subtitle button on the remote once and the subtitle info banner appears. When a DVD or SVCD is recorded with subtitles, you can use the Subtitle feature to view the subtitles on-screen. By default, subtitles are off. The info banner will display Subtitle Off.

To display subtitles, press the Subtitle button again. The default language with its corresponding serial number will be displayed in the info banner and subtitles will be displayed in that language. There are 8 supported subtitles: Chinese, English, Japanese, French, Spanish, Portuguese, Germany and Latin. With each consecutive press of the Subtitle button, the subtitle switches. For example, "Language Icon: [1 English DTS 6CH] or [Off]" (the availability of the subtitles are disc-dependent). To turn subtitles off, press the Subtitle button until Subtitle Off is displayed.

13. Changing the Camera Angle (compatible with DVD discs)

During disc playback, press Angle on the remote once and the angle icon appears. Some DVDs contain multiple angles of a particular scene or sequence, so you can use the Angle feature to view.

Press the Angle button again to go to the next camera angle. If multiple camera angles are available, the Angle icon displays the current angle number and the number of angles available. For example: "Angle Icon: [*/] or [Off]"; 1/4" indicates that angle one is being displayed and there are four different angles available. (This feature is disc-dependent. If no additional camera angles are available, the "Invalid Key" will be displayed).

14. Changing the TV System (compatible with DVD, SVCD, VCD, CD, CD-G, DTS-CD, HD-CD, MP3/JPEG discs)

Press P/N button on the remote to display current TV system.

Press the P/N button again to change to the next TV system. There are four systems: NTSC, PAL60, PAL and AUTO. With each consecutive press of the P/N button, the TV system switches. If you press the button five times, the TV system cycles back.

Notes:

- If AUTO TV system is selected, it can auto reach the highest definition depending on the disc.
- If it isn't full screen state (**Note:** Wide Screen program would never reach full screen state) or in black and white, press the P/N button to adapt TV System to the TV set of NTSC or PAL.
- When playing in different TV system, some discs may not have their features entirely fulfilled in some certain standard.
- Auto System of TV set is recommended.

15. Mute the Audio Output (compatible with DVD, MPEG-4, Divx, SVCD, VCD, CD, CD-G, DTS-CD, HD-CD, MP3/JPEG discs)

Pressing the Mute button allows you to reduce sound to an inaudible level and "MUTE" will be displayed on screen. Press the button again or press the Vol +/- button to return to the normal condition.

ADDITIONAL OPERATION

Notes:

- When muted, the microphone also has no audio output.
- If a disc has no sound, please try to press the Mute button to resume.

16. Zoom In the Video Image (compatible with DVD, MPEG-4, Divx, SVCD, VCD, JPEG discs)

- a) The Zoom Function allows you to enlarge or zoom out the video image and to pan through the image. Press Zoom repeatedly to activate the function and choose the required zoom factor: Zoom 1, Zoom 2, Zoom 3, Zoom 1/2, Zoom 1/3, Zoom 1/4, Zoom Off.

Notes:

- This feature does not work when the Disc Menu appears.

- b) Use the Arrow buttons to pan across the screen when the zoom factor is 1, 2 or 3.

17. Repeat a Specific Segment on the Disc that You Define (compatible with DVD, MPEG-4, Divx, SVCD, VCD, CD, CD-G, DTS-CD, HD-CD, MP3 discs)

- a) During the normal or fast motion playback, press the A-B button once and "REPEAT A" will appear on the screen. This indicates the start of the loop to be repeated.
- b) During the normal or fast motion playback, press A-B again and "REPEAT A-B" will appear on the screen. It indicates the end of the loop.
- Looping will run from set point A to set point B until you turn off Repeat.
- c) Press A-B again to cancel A-B loop mode.
- When playing a SVCD, VCD or CD disc, you can repeat a specific segment only in one track. When the next track begins, A-B Repeat turns off automatically.
 - When playing a DVD disc, you can repeat a specific segment only in one title/chapter.

18. 3D Surround Mode (compatible with SVCD, VCD, CD, CD-G, HD-CD, MP3 discs)

Press the 3D button on the remote once and current 3D surround mode info will be displayed on the screen. Press the Arrow buttons to highlight the 3D surround setup menu items; Press the 3D button again to turn off the menu.

- Use the Up/Down arrow buttons and press Enter to choose surround mode.

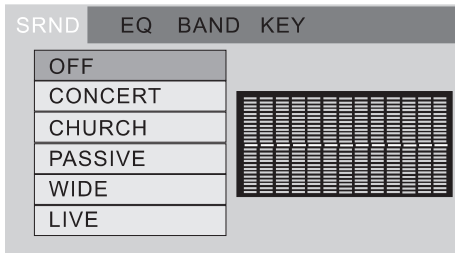

ADDITIONAL OPERATION

- “EQ: [STANDARD]” is highlighted, as shown below.

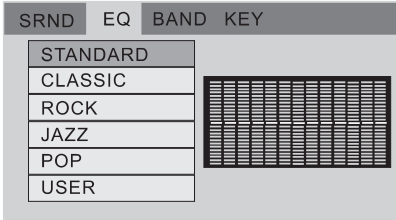

- “EQ: [CLASSIC]” is highlighted, as shown below.

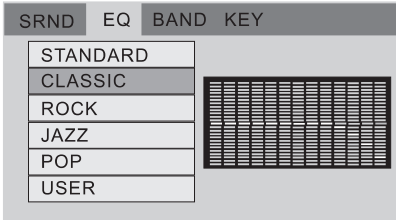

- “EQ: [ROCK]” is highlighted, as shown below.

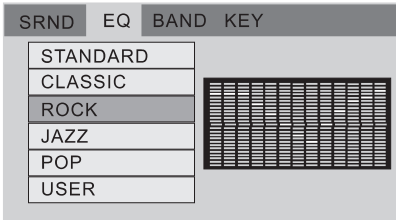

- “EQ: [JAZZ]” is highlighted, as shown below.

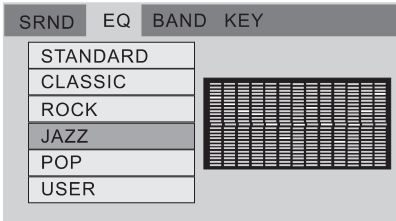

- “EQ: [POP]” is highlighted, as shown below.

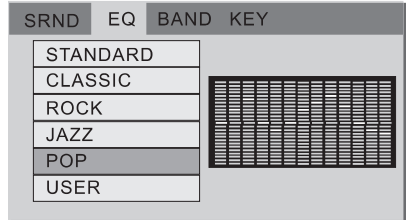

- “EQ: [USER]” is highlighted, as shown below. The graph can vary according to your settings: Press the Left/Right arrow buttons to highlight the band you want to tune; Then press the Up/Down arrow buttons to increase or decrease the value.

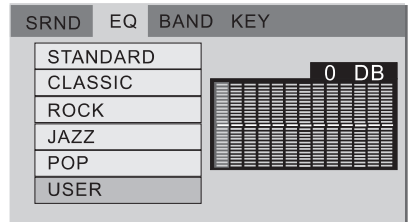

- Display the Band

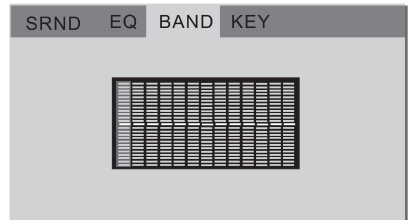

- Adjust the key

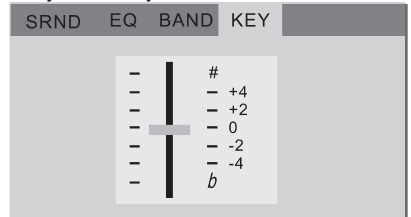

IDENTIFICATION OF CONTROLS

Notes:

- When setting SRND, EQ is auto setup to STANDARD.
- When setting EQ, SRND is auto setup to OFF.

19. Volume control (compatible with DVD, MPEG-4, Divx, SVCD, VCD, CD, CD-G, DTS-CD, HD-CD, MP3/JPEG discs)

- You can press the Volume button on the front of the TV set or the amplifier to control the sound level.
- Pressing the Vol+ button on the remote allow you to amplify the sound level; Pressing Vol- will reduce the sound level.

Notes:

- During DVD PCM output playback, this feature does not work.

MPEG-4 and Divx

Chapter 3: MPEG-4 and Divx

MPEG-4 is a graphics and video lossy compression algorithm standard. It is based on MPEG-1 and MPEG-2 and Apple Quicktime technology. Wavelet based MPEG-4 files are smaller than JPEG or Quicktime files, so they are designed to transmit video with text, graphics and 2-D and 3-D animation layers. Wavelet technology can compress color images at rates of 20:1 up to 300:1 and grayscale images at 2 to 50:1

DIVX is based on the MPEG-4 compression format. It is a new pay-per-view version of the DVD movie-on-a-CD format. The discs are cheap to buy. DIVX discs are encrypted and cannot be played in normal DVD players nor in the DVD-ROM drives in newer computers.

Currently, the version of DIVX have DIVX 3.11, DIVX 4.12 and DIVX 5.05. Support MP subtitle, includes: English, simplified Chinese, complicated Chinese, Japanese, Russian, West Europe and Middle Europe languages but doesn't support several subtitles at the same time.

SETUP MENU SYSTEM

Chapter 4: SETUP MENU SYSTEM

1. General Steps of Setup Menu

- a) Press the Setup button, the main setup menu appears.
- When the main menu is displayed, the DVD system will auto pause.

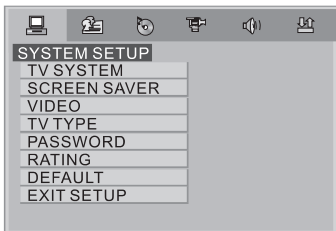

- b) Press the Left and Right arrow buttons to highlight the icon of the desired page, then press the Down or Right arrow button to activate that page; For example, if you want to setup the video page, press Right to highlight the video icon, the video page will be displayed on the screen.

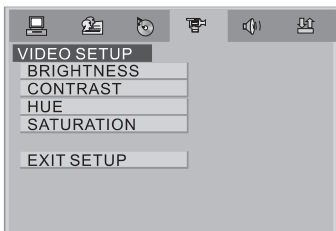

- c) Press the Down arrow button to highlight the desired option. Press Enter or press Right to select, the choices of that option appear on the right; For example, press the Down arrow button to highlight the BRIGHTNESS option, then press Enter to select, the brightness choices appear on the right.

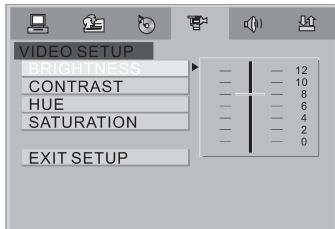

- d) Press the Arrow buttons to highlight the Exit Setup option, then press Enter or Setup again to exit Setup Menu.

Notes:

- When setup is complete, pressing the following buttons will turn off the setup menu, while the choices that have been changed will be saved: P/N, Subtitle, F.F, F.R, Vol +/-, PBC, Title, Return, Play, Stop, Resume, Pause/Step, Next, Prev, S.F, S.R, Zoom, Preview, Goto, Program, Repeat, A-B, Angle, language, Soundtrack, 3D, Record, Display, Mute, Setup.

2. Setup Items Introduction

a) SYSTEM SETUP

The system setup options are illustrated below:

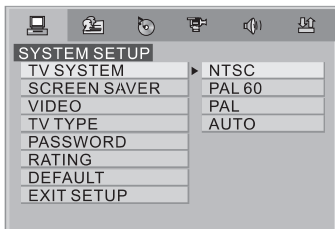

* TV SYSTEM

According to the Color System of the TV, you can choose the TV System.

- AUTO: Choose this settings if your DVD player is connected to a multi-system TV.
- NTSC: Choose this setting if your DVD player is connected to a NTSC TV.
- PAL: Choose this setting if your DVD player is connected to a PAL TV.
- PAL60: Choose this setting if your DVD player is connected to a PAL60 TV. The default setting is NTSC.

SETUP MENU SYSTEM

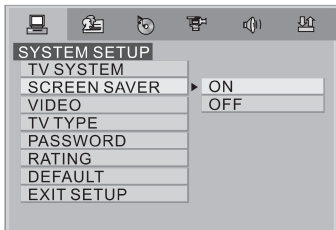

* SCREEN SAVER

If the screen saver is on, when your DVD player is in Stop, Open or No Disc state, or there is a frame frozen for more than 60 sec, the screen saver will be displayed. This feature can protect the screen from damage.

- ON: Choose this setting to activate the screen saver.
- OFF: Choose this setting to cancel the screen saver.

The default setting is ON.

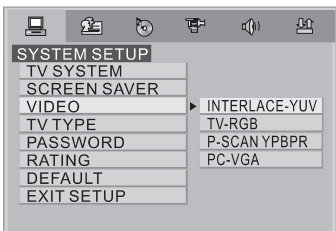

* VIDEO

- Interlace-YUV: Choose this setting if your DVD player is connected to a TV with Y, Cb, Cr video cables.
- TV-RGB: Choose this setting if your DVD player is connected to a TV with an S-Video cable or composite video cables.
- P-SCAN: Choose this setting if your DVD player is connected to a progressive scan TV with Y, Cb, Cr video cables.
- PC-VGA: Choose this setting if your DVD player is connected to a progressive scan TV or a monitor with a VGA video cable.

Notes:

- When your DVD player output is composite video, these settings have no effect.
- Choose TV-RGB/P-SCAN if your DVD player is connected to a progressive scan TV. The default setting is TV-RGB.

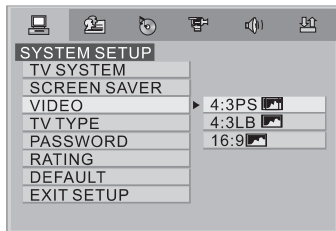

* TV TYPE

- 16 : 9 (Wide Screen): Choose this setting if your DVD player is connected to a wide screen TV. If you choose this setting and you don't have a wide screen TV, the images on the screen may appear distorted due to vertical compression.
- 4 : 3 LB (Letter Box): Choose this setting if your DVD player is connected to a normal ratio TV connector. You will see the movies in their original aspect ratio (height-to-width ratio). You will see the entire frame of the movie, but it will take up a smaller portion of the screen vertically. The movie might appear with black bars at the top and bottom of the screen.
- 4:3 PS (Pan and Scan): Choose this setting if your DVD player is connected to a normal ratio TV. You can fill the movie to the entire screen of your TV. This might mean that parts of the picture (the left and right edges) won't be seen.

Notes:

- The image display ratio is related to the recorded disc format. Some disc can not display images in the aspect ratio you choose.
- If you play a disc recorded in 4:3 format on a wide screen TV, black bars will appear on the left and right side of the screen.
- You must adjust the screen setting depending on the type of the television you have.

SETUP MENU SYSTEM

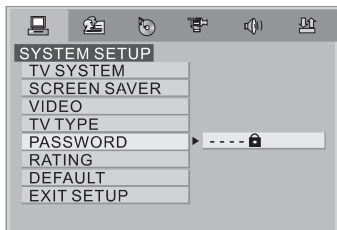

* PASSWORD

The password option is initially locked, and you cannot set the ratings limit or change the password. In order for the Ratings feature to work, the password mode must be turned on. If you want to set the ratings limit, you will need to enter the default password, which is 0000, then press Enter to confirm. To change the password, you will be prompted for the old password, then be prompted for a new password. Enter a 4-digit number (this is your new password).

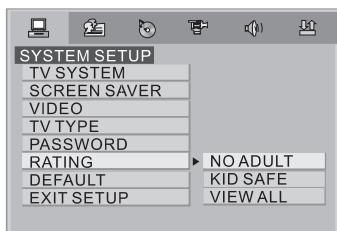

* RATING

The Rating feature is a rating limit system, like movie ratings. It works with DVD discs that have been assigned a rating. This helps you control the types of DVDs that your family watches.

- There are two rating options: NO ADULT and KID SAFE.
- Select the VIEW ALL option to cancel the rating limit.

The default setting is VIEW ALL.

Notes:

- If the password option is locked, you cannot set the ratings limit; the rating limit does not work when the password option is unlocked.

* DEFAULT

Choose this option to resume all the setup options to default settings.

b) LANGUAGE SETUP

The language setup options are illustrated below:

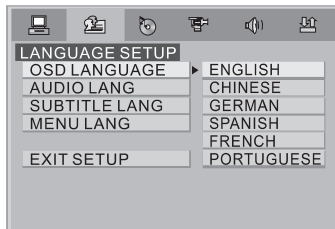

* Highlight the OSD LANGUAGE option and press the Arrow buttons to choose the OSD language you prefer. Press Enter to confirm and it will display OSD in that language; There are 8 optional OSD languages: Chinese, English, Japanese, French, Spanish, Portuguese, German and Latin.

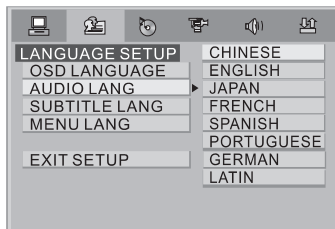

* Highlight the AUDIO LANG option and press the Arrow buttons to choose the audio language you prefer. Press Enter to confirm. If the disc you are playing has that language available, it will output audio in that language; There are 8 optional audio languages: Chinese, English, Japanese, French, Spanish, Portuguese, German and Latin.

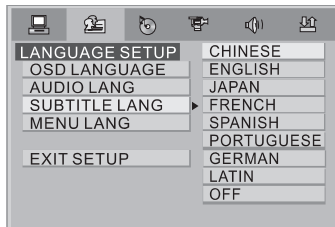

SETUP MENU SYSTEM

* Highlight the **SUBTITLE LANG** option and press the Arrow buttons to choose the subtitle language you prefer. Press Enter to confirm. If the disc you are playing has that language available, it will display subtitles in that language; There are 8 optional audio languages: Chinese, English, Japanese, French, Spanish, Portuguese, German and Off.

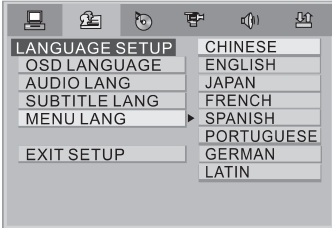

* Highlight the **MENU LANG** option and press the Arrow buttons to choose the menu language you prefer. Press Enter to confirm. If the disc you are playing has that language available, it displays the menu in that language; There are 8 optional menu languages: Chinese, English, Japanese, French, Spanish, Portuguese, German and Off.

Notes:

- If your preferred language isn't available, the disc's default language will be played.
- The default language of your DVD player is Chinese.

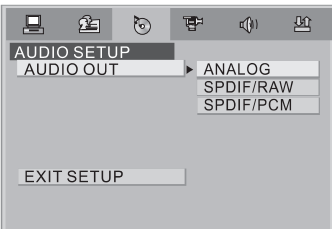

c) AUDIO SETUP

The audio setup options are illustrated below:

Highlight the **AUDIO OUT** option and press the Arrow buttons to choose the audio output mode you prefer. Press Enter to confirm; There are 3 optional audio output modes: ANALOG, SPDIF/RAW and SPDIF/PCM.

- **ANALOG:** From the Coaxial Output jack and the Optical Output jack, no signal is output.
- **SPDIF/RAW:** Choose this setting if your DVD player is connected to a power amplifier with a coaxial cable or an optical cable; When playing a disc recorded with Dolby Digital, DTS and MPEG audio formats, the corresponding digital signals will be outputted from the Coaxial Output jack or Optical Output jack. This player's digital output jacks are designed for a connection to a Dolby Digital, DTS, or MPEG receiver or decoder.
- **SPDIF/PCM:** Choose this setting if your DVD player is connected to a 2-channel digital stereo amplifier; When playing a disc recorded with Dolby Digital and MPEG audio formats, audio signals will be modulated into a 2-channel PCM signal and it will be outputted from the Coaxial Output jack or Optical Output jack.

d) VIDEO SETUP

The video setup options are illustrated below:

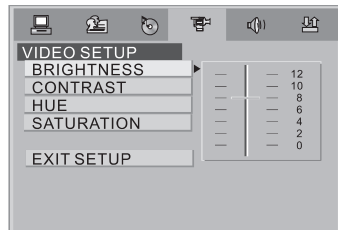

* BRIGHTNESS

Use the Up and Down arrow button to move the scroll indicator and adjust the brightness.

SETUP MENU SYSTEM

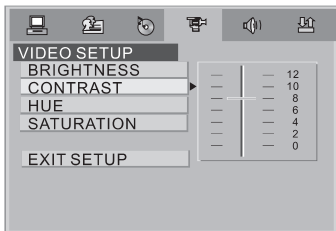

* CONTRAST

Use the Up and Down arrow button to move the scroll indicator and adjust the contrast.

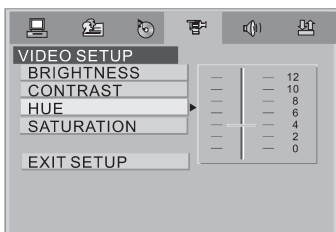

* HUE

Use the Up and Down arrow button to move the scroll indicator and adjust the hue.

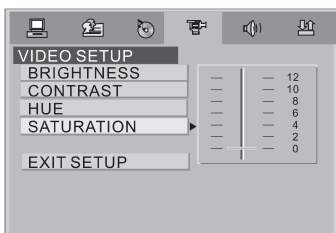

* SATURATION

Use the Up and Down arrow button to move the scroll indicator and adjust the saturation.

e) SPEAKER SETUP

The speaker setup options are illustrated below.

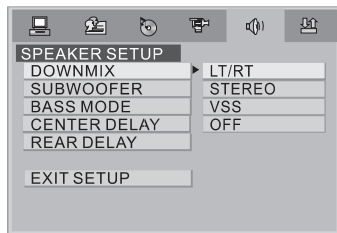

* DOWNMIX

Use the Up and Down arrow button to move the scroll and adjust the saturation.

- LT/RT: Choose this setting and it will sound like in a movie theatre if the original movie disc was recorded from was encoded in the Pro Logic Dolby Digital format.
- STEREO: Choose this setting, when 5.1-channel sound playing, two channels of signals will be outputted from the left and right soundtrack; when 2-channel sound playing, stereo signal will be outputted.
- VSS: Choose this setting when a disc is recorded with 5.1 channel sound. The fictitious surround soundtracks effect will be heard from the main soundtrack.
- OFF: Choose this setting to output the 5.1-channel sound.

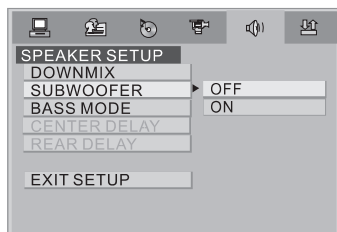

* SUBWOOFER

There are two settings in this option: OFF/ON. When ON is chosen, the player will auto detect the subwoofer input then output it. When OFF is chosen, the subwoofer input will not be outputted.

SETUP MENU SYSTEM

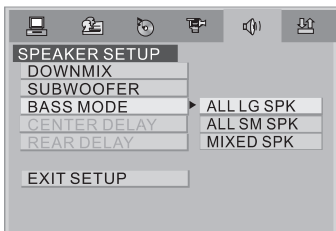

* BASS MODE

There are three settings in this option: ALL LG SPK, ALL SM SPK, MIXED SPK. You can adjust subwoofer volume in this option.

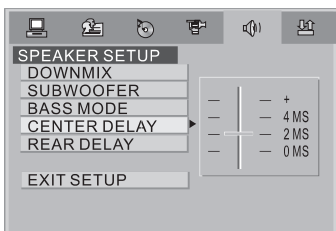

* CENTER DELAY

You can adjust center delay in this option.

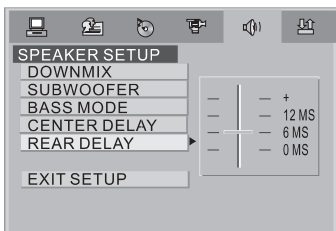

* REAR DELAY

You can adjust center delay in this option.

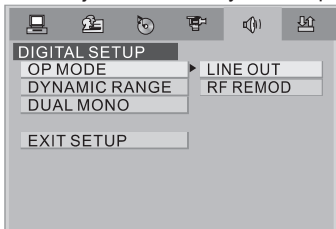

f) DIGITAL SETUP

The video setup options are illustrated below:

OP MODE

- **LINE OUT:** Choose this setting to line out the input signal. It will be more suitable for playing in the night time when the output volume is low.
- **RF REMOD:** It will be more suitable to choose this setting for playing in the day time when the output volume is high.

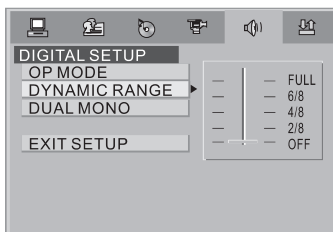

- * **DYNAMIC RANGE:** When "LINE OUT" is selected, choose this setting to adjust the line out ratio and get different effect. If adjusting to FULL, the audio signal peak value will be the minimum; while adjusting to OFF, maximum.

NOTE:

This option will be disabled when the DOWNMIX is OFF.

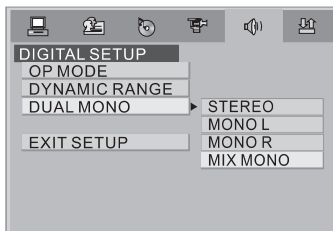

* DUAL MONO (LEFT + RIGHT)

Choose this option to setup the L and R mono output mode; There are four modes in this option: STEREO, MONO L, MONO R and MIX MONO; It is mainly used in karaoke mode.

SETUP MENU SYSTEM

REFERENCE:

- To protect your DVD player, the interval between two consecutive Power Button operations must be above 30 seconds.
- If not using for an extended period or time, please pull out the plug from the power outlet.
- The player should be operated only on the appropriate type of power supply. Otherwise, it doesn't work or may even be damaged.
- The player may not be compatible with some encrypted discs.
- If the player stops playback by accident, please power it on again.

TROUBLE SHOOTING

If your DVD player developed a problem, please check below situations before requesting service.

PROBLEM	CHECK and ACTION
No Power	<ul style="list-style-type: none"> • Check if the power cord has been properly connected to the power outlet. • Check if the main power has been switched on.
Does not play	<ul style="list-style-type: none"> • No disc, load a disc. • Disc has been loaded upside down. Place the disc with the label side up. • Disc's region code does not match to the player. • Disc's rating level is higher than the player's rating level setting. • Disc is not the correct type for the player. • Disc is damaged or dirty, clean the disc or try another disc. • Moisture may be condensed inside the player. Remove the disc and leave the unit power on for one or two hours.
No picture	<ul style="list-style-type: none"> • Check if the TV set has power on, use TV remote to select A/V signal for DVD rather than broadcast. • Check if the system connection is proper and secure. • Check if the connection cables are damaged. • Clean the disc. • Please press the OPEN button, then press the PROGRAM and ZOOM button to return factory default status.
Picture noise/distorted	<ul style="list-style-type: none"> • The disc is dirty or damaged. Clean the disc or try another disc. • Reset the color system of the TV set. • Try to connect the player directly to the TV set, without via a VCR for example.
Picture not full screen	<ul style="list-style-type: none"> • Select the screen format from the player's SETUP MENU, see "SETUP MENU" of this manual. • Select the screen format from DVD disc menu.
Problem message display on screen	<p>Following message will display when there is a problem with the loaded disc:</p> <ul style="list-style-type: none"> • <u>"WRONG REGIONAL DISC"</u>: Disc's region code does not match to the player. • <u>"WRONG PASSWORD"</u>: The player refuse to play a disc with rating level higher than the player's rating level setting, or input the wrong password in the setup menu. • <u>"WRONG DISC"</u>: The player is equipped with automatic disc quality detection software. When the player detects a problem disc or a damaged disc, the player may keep playing the disc at lower quality or stop playing, depending on the damage level of the disc.
Malfunction	<ul style="list-style-type: none"> • Should the player develop a malfunction, unplug the player for 30 minutes. After 30 minutes, power on the player and the restore function should reset the player.

TROUBLE SHOOTING

Symptom	Check and Action
Cannot SKIP or SEARCH	<ul style="list-style-type: none"> • Some discs are programmed that do not allow users to SKIP or SEARCH at some sections, especially at the beginning WARNING section. • Single Chapter disc cannot apply SKIP function.
No sound or sound output not complete	<ul style="list-style-type: none"> • Check if the TV and Amplifier have been switched on and correctly set. • Check if the TV and Amplifier system connection is secured. • Press the AUDIO button to select other audio tracks output of disc. • Check if the MUTE function of the TV or Amplifier has been activated. • There will be no sound output during REVERSE PLAY/PAUSE/STEP/SLOW and SEARCH.
MP3 disc has no sound or is noisy	<ul style="list-style-type: none"> • When PC program files or other data files are mixed with MP3 files in the same disc, the player may play the non-MP3 files with noise or no sound. • Check the disc, if all the files on disc are MP3 files. Skip the file, try other files.
Remote control does not function	<ul style="list-style-type: none"> • Remove the obstacles between the remote control and the player. • Point the remote control towards the remote sensor on the player. • Check if the batteries of the remote control have been loaded with correct polarities. • Replace the batteries of the remote control.
Type of Disc	DVD CD-DA CD-MP3 CD-R/CD-RW

If your PROBLEM cannot be settled after checking the above methods, please contact a qualified servicing personnel. NEVER attempt to remove the cover (or back) of the unit by yourself.

SPECIFICATIONS

Video Format	Divx3.11, Divx4.12, Divx5.05, MPEG-4, DVD Video, DVD Audio, Super Video CD, Video CD, CD-DA, HDCD, OKO, CD-ROM.
Audio Format	MPEG 1, LAYER 1, LAYER 2, LAYER 3
Signal Output	Color System: PAL/NTSC Audio System: DOLBY DIGITAL down mix stereo DOLBY DIGITAL digital output Audio DAC 24bit/96KHz Video Output: 1 Vpp (at 75 ohm) Audio Output (Stereo): 2 Vpp
Frequency Response	CD: 20Hz-20KHz (EIAJ) DVD: 20Hz-22KHz (48K) 20Hz-44KHz (96K)
S/N ratio	> 90 dB
THD	< 0.05%
Output Terminals	Video (composite) output S-video output Component Video (Y Pb Pr) output Digital audio output: coaxial Down mix (L/R) Scart (optional)
Power Input	AC 110-240V 50/60Hz 20W (Max.)
Dimension	17" x 10" x 1 1/2" (430mm x 253mm x 38mm)

WARRANTY



LIMITED WARRANTY

Who is Providing This Warranty?

- Orbyx Electronics, LLC ("Orbyx"), as the distributor of this Nexxtech™ product (your "Product").

What Does This Warranty Cover?

- This warranty covers defects in materials or workmanship in your Product under normal use and conditions.

What is the Period of Coverage?

- This warranty covers your Product for 12 months from the original purchase date.

Who is Covered?

- This warranty covers the original consumer purchaser. Coverage terminates if you sell or otherwise transfer your Product.

What Will We Do To Correct Problems?

- We will repair your Product or replace your Product with a new or reconditioned equivalent product, at our option.

How Do You Get Service?

- Call Orbyx TOLL FREE at 1-866-363-3059 for instructions for obtaining warranty service from Orbyx's authorized service providers.
- Or, return your Product directly to the retail store from which you purchased the Product.
- When you obtain service for your Product, you must provide a purchase receipt (or other proof of the original purchase date) and a description of the defect(s).

What Does This Warranty Not Cover?

- This warranty DOES NOT COVER:
 - damage due to misuse, abuse, alteration, unauthorized repair, or accident (such as improper electrical current);
 - damage due to "acts of God" (such as lightning) or other contingencies beyond our control;
 - cosmetic damage;
 - externally generated static, signal reception or antenna problems not caused by your Product; or batteries.
- This warranty also DOES NOT COVER, and in no case will we be liable for, any incidental damages (such as transportation costs to and from an authorized service provider, or loss of time) or consequential damages (such as costs of repairing or replacing other property which is damaged, including tapes, discs, speakers not included with your Product or other accessories, or external electrical systems) resulting from the use of your Product. Some states do not allow the exclusion or limitation of incidental or consequential damages, so the above limitation or exclusion may not apply to you.
- Defacing the serial number, or using your Product for commercial or institutional purposes, voids this warranty.

Are There Other Warranties?

- There are no express warranties other than those expressed herein. Neither the sales personnel nor any other person is authorized to make any other warranties or to extend the duration of any warranties.
- ANY IMPLIED WARRANTIES, INCLUDING ANY IMPLIED WARRANTY OF MERCHANTABILITY (AN UNWRITTEN WARRANTY THAT A PRODUCT IS FIT FOR ORDINARY USE), ARE LIMITED TO 90 DAYS. Some states do not allow limitations on how long an implied warranty lasts, so the above limitation may not apply to you.

How Does State Law Apply?

- This warranty gives you specific legal rights, and you may also have other rights which vary from state to state.



LIMITED WARRANTY

ORBYX ELECTRONICS WARRANTY

ORBYX Electronics warrants that this product will be free from defects in materials and workmanship for a period of one (1) year from the date of purchase. Within this period, simply take the product and your proof of purchase to any ORBYX Electronics store or dealer and the product will be repaired without charge for parts and labour. ORBYX Electronics reserves the right to charge for transportation. Any product which has been subject to misuse or accidental damage is excluded from this warranty. This warranty is only applicable to a product purchased through ORBYX Electronics' company owned stores and dealers and to a product that is presented for repair in a country where ORBYX Electronics offers the product for sale. While this warranty does not confer any legal rights other than those set out above, you may have additional statutory rights which will vary under the laws of the various countries, states, province and other governmental entities in which ORBYX Electronics operates. This warranty is subject to all statutory rights you may have in the country of purchase.

Distributed exclusively in the U.S. by
Orbyx Electronics, LLC
501 South Cheryl Lane,
Walnut, CA 91789

Imported in Canada for/Importé au Canada pour
Orbyx Electronics,
Concord, Canada, L4K 4M3

Manufactured in China

For product support please contact www.orbyxelectronics.com
or 1-866-363-3059



Limited Warranty/Garantie Limitée
U.S.A & Canada

© 2004 ORBYX Electronics. All Rights Reserved.

